

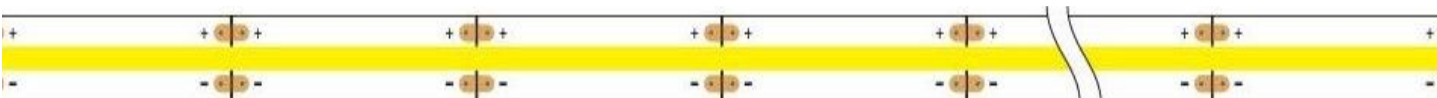

### Product Description

Infinity Green Lighting Corporation LED Strip was designed and created to make innovation an objective with unique designs. Our strip allows low power usage with LED features extending up to 5 meters (16.4 ft) with adjustable cutting size up to your preference and serves at the top quality in the market. One driver and voltage regulator is enough to run the strip efficiently. In order to reduce time installation on the LED Strip, installation was simply allowed on most surfaces with 3M double-sided tape.



### Specification Information

Length:	5m (16.4ft)
Rated Power	24v/75W
Chips:	528 Pcs/m
Cutting Unit:	Every 1.78 in (45.45mm)
Environment:	Indoor
CRI:	90
Lumen Per Watt:	105
Certification:	UL Listed
Life Span Warranty:	3 Years

### Features

- Decent Display Light Source
- Under-Shelf & Under Cabinet
- User and Installation Friendly
- Long Distance Strip Run
- Low Profile/Great Flexibilities
- 3M Installation Stick Tapes
- Various Dimmable Option
- Channel Options
- Adjustable Cutting

### Ordering Steps

#### Product Purchasing Guideline

	Model Number	-	Color Temperature	-	Meter
Ex:	PL-24	-	3090	-	5M
	PL-24		2790 - 2790K 3090 - 3000K 4090* - 4000K 5090 - 5000K		5M





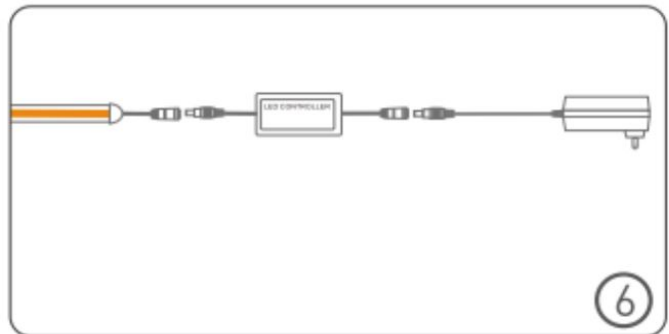
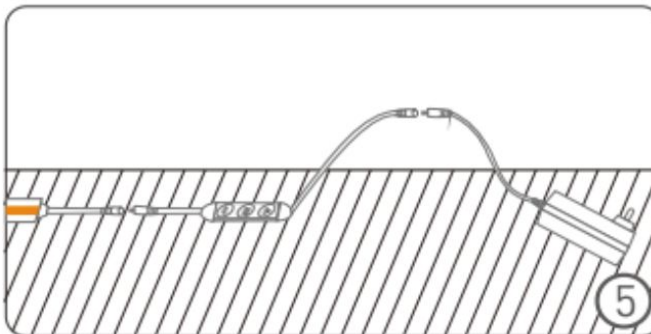
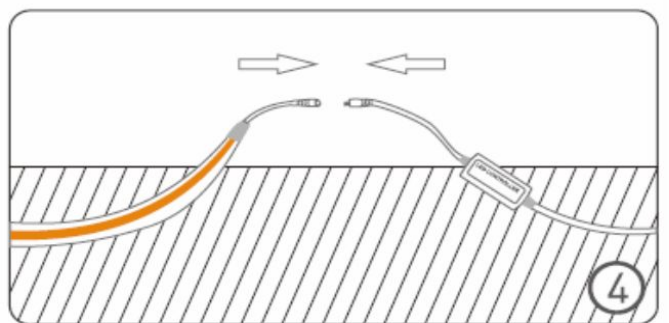
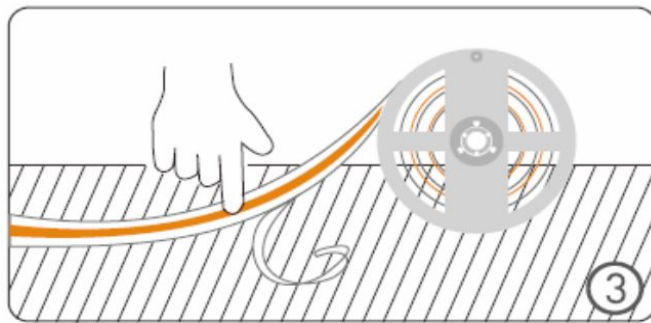
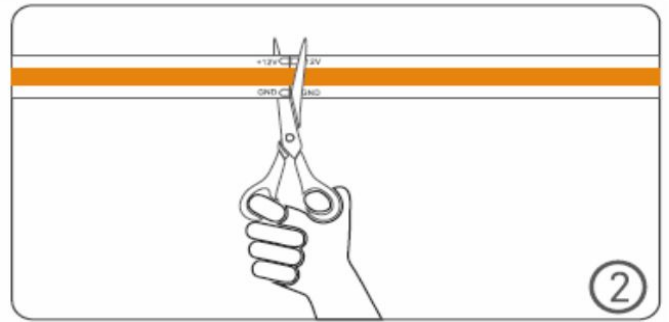
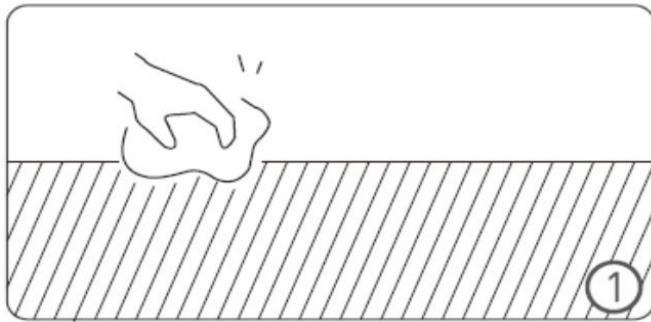

# Installation Steps



# Wiring



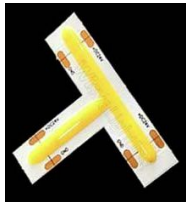
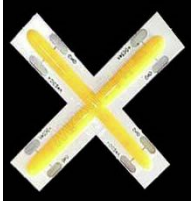
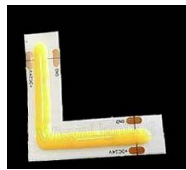

Connection Accessories	
	<b>PL-CON</b> <b>COB Connectors</b>
	<b>PL-JCON</b> <b>COB Jumper Connectors</b>
	<b>PL-DRC</b> <b>COB Direct Connectors</b>
	<b>PL-TCON</b> <b>COB T Connector</b>
	<b>PL-XCON</b> <b>COB X Connector</b>
	<b>PL-TCON</b> <b>COB L Connector</b>
	<b>PL-SG-C1</b> <b>11 Keys Single Color Mini Controller</b>



**LED-Flexible Linear Strip**

One of the most common ways to install LED strip light is with an LED channel. In addition to protecting and concealing your LED strip, it provides a polished and professional look for your lighting installation. We offer channels that can be surface mounted, hung, clip mounted, recessed, magnetically adhered and stair mounted. Channel systems consist of two main parts: aluminum channel and a diffuser or lens. We offer a number of standard designs, as well as some specialized extrusions for specific applications. (More Detail: [www.infigreen.com/channel-led/](http://www.infigreen.com/channel-led/))

**Aluminum Channel (Accessories)**

	<b>ALP6002 - 8mm Slim Aluminum LED Profile For Surface Mounted</b>		<b>ALP6081R Aluminum profile with PC opal cover</b>
	<b>ALP6013 Aluminum LED Profile For Recessed</b>		<b>ALP6071 Aluminum LED Profile Trimless Recessed</b>
	<b>ALP6014 Aluminum LED Profile For Surface Mounted</b>		<b>ALP6110R Trimless Recessed LED Aluminum Profile Channel</b>
	<b>ALP6083R Aluminum profile with PC opal cover</b>		<b>ALP6110S Aluminum LED profile with 1inch Square Lens</b>



## Safety Instructions

1. Open the package and check if all the components are complete, then unrolling the led strip, and connect the COBstrip to controller and driver and light it up to check if all parts are in good condition or not. The connect method should refer to the wiring diagram.
2. Clean the surface on the installation surface, make sure it's clean, dry and smooth, Or it will reduce the adhesiveness of the back tape. Remember the back tape could be only used one time. The COB strip will fall off if the surface is not in good condition or the back tape is reused.
3. Measure the length required on the surface and cut the COB strip accordingly.
4. Tear off the back tape and paste the strip to the surface smoothly and correctly. Connect the COB strip to the controller and driver based on the diagram.
5. Fix the driver, make sure all the components are tightly and not fall off.

## Warning

1. Do not use it outdoors or underwater.
2. Disconnect the power before installation.
3. The operating temperature for the installation surface should be less than 40°C.
4. Do not use the products close to flammable materials.
5. The 75W only for 16.4ft(5m) COB strip, do not afford to Another COB strip or it would be overloaded.
6. Do not power the COB strip while it's rolled, or it will overheat and damage.
7. Do not power the COB strip by another power source, like 120VAC or 120VDC, the electronic components will be damaged.
8. Keep the components from children.

## Customer Service

In order to ensure the product's highest quality and our service. Please contact us at (sales@infigreen.com) for any concerns or questions regarding our product. We will reply within 24-48 Hours during our regular office hours Monday to Friday excluding weekends and holidaysThank You For The Interest In Our Product!