

INFINITY GREEN LIGHTING

(Installation Safety User Manual)

Model: LS24REDKIT

Color Temperature: **Red**

Packing Product List

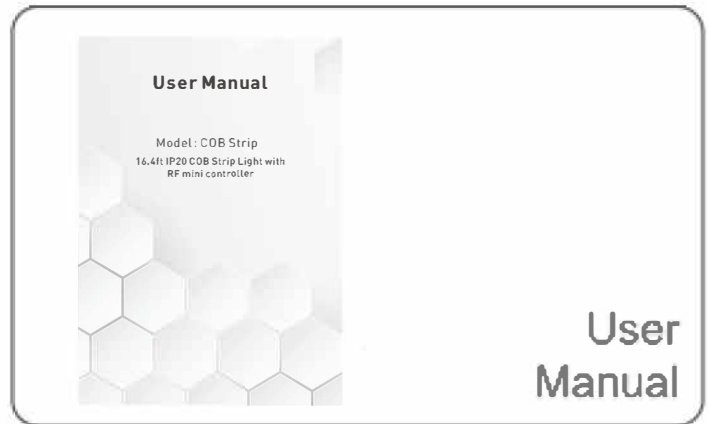

- Plug-in UL 36W adapter x1
- Mini Controller with RF 11 Key remote x1
- 16.4ft 320 Chip COB LED Strip x1
- User Manual x 1

Specifications

Length:	16.4ft
Rated Power (LED Strip):	24v/30W
Chips:	320 Pcs/m
Cutting Unit:	Every 3.93 inch
Dimmer:	Mini Controller
Adapter:	AC100-240V, 50-60Hz
Rated Power (Adapter):	36V1.5A/36W

Wiring

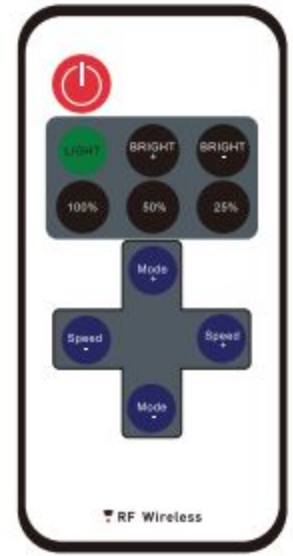
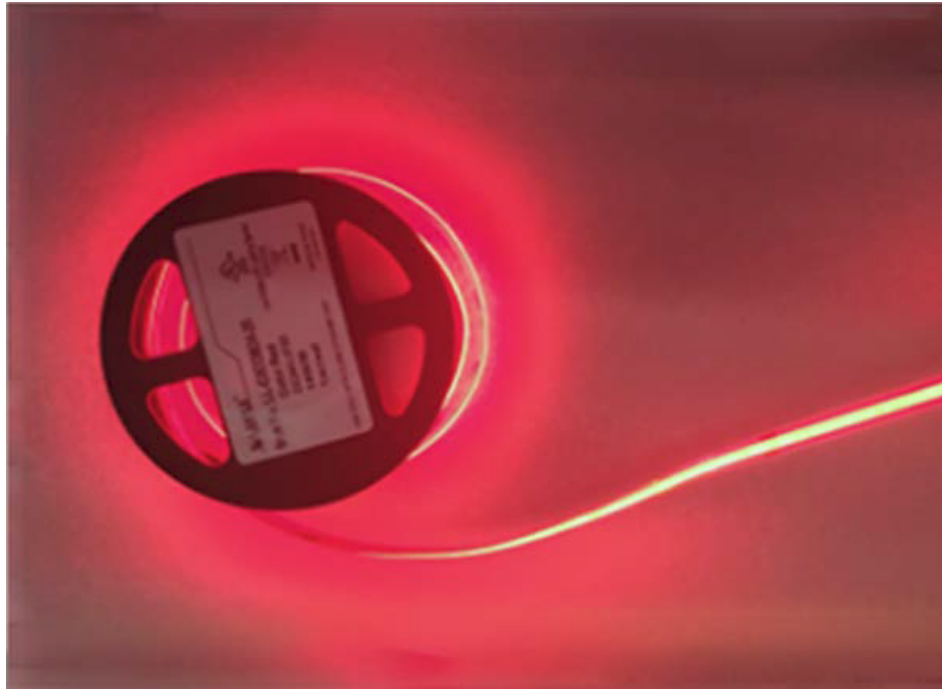
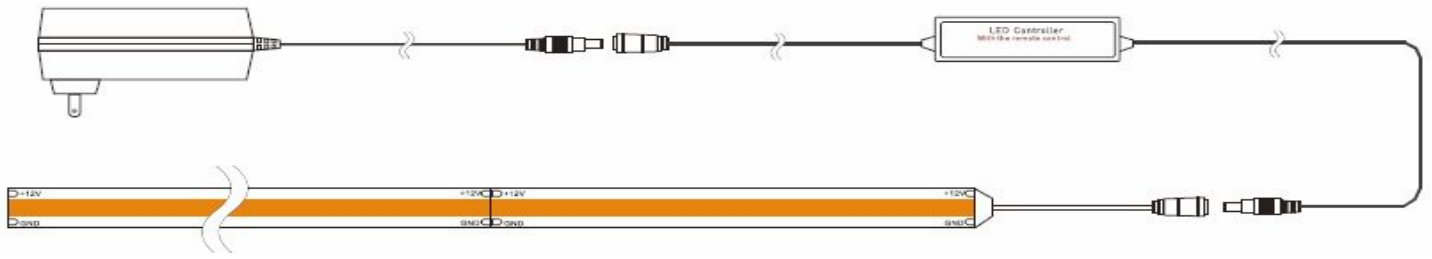

Installation Steps

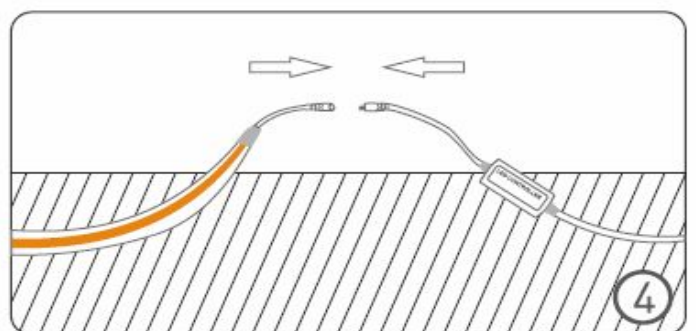
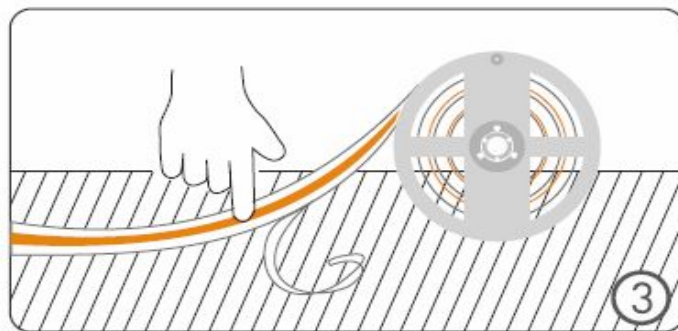
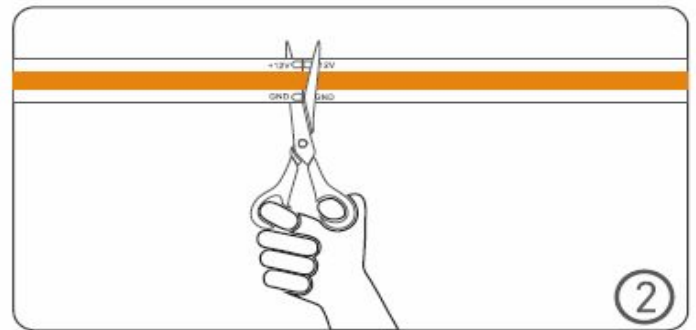
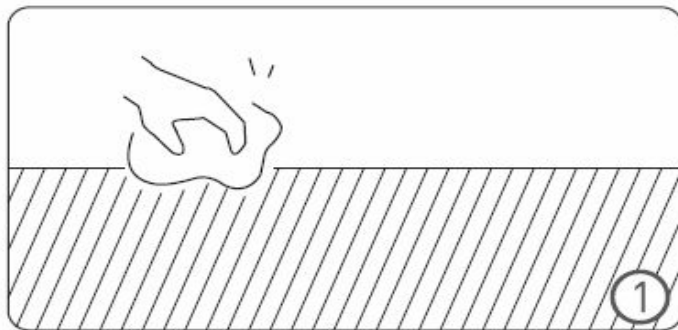

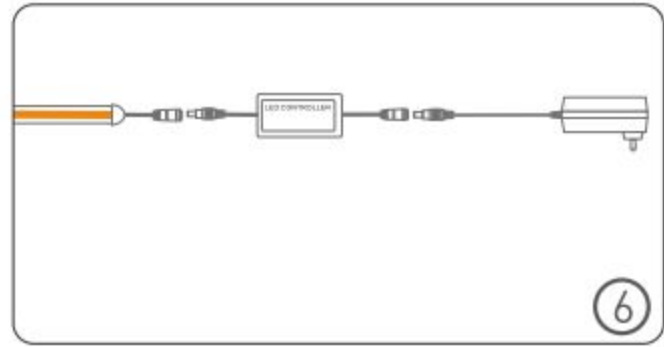
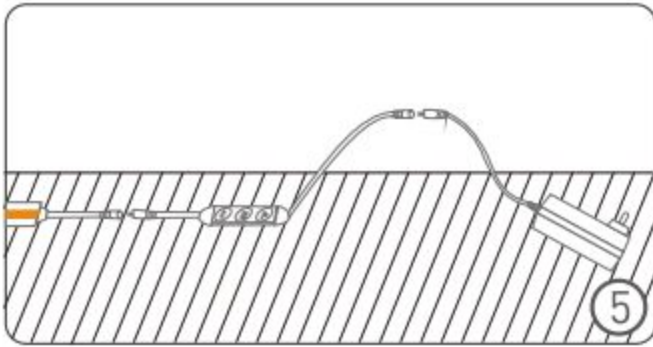

Instructions

1. Open the package and check if all the components are complete, then unrolling the led strip, and connect the COBstrip to controller and driver and light it up to check if all parts are in good condition or not. The connect method should refer to the wiring diagram.
2. Clean the surface on the installation surface, make sure it's clean, dry and smooth, Or it will reduce the adhesiveness of the back tape. Remember the back tape could be only used one time. The COB strip will fall off if the surface is not in good condition or the back tape is reused.
3. Measure the length required on the surface and cut the COB strip accordingly.
4. Tear off the back tape and paste the strip to the surface smoothly and correctly. Connect the COB strip to the controller and driver based on the diagram.
5. Fix the driver, make sure all the components are tightly and not fall off.

Warning

1. Do not use it outdoors or underwater.
2. Disconnect the power before installation.
3. The operating temperature is -10°C to $+40^{\circ}\text{C}$, please make sure the installation surface should be less than 40°C .
4. Do not use the products close to flammable materials.
5. The 36W adapter only for 16.4ft(5m) COB strip, do not afford to Another COB strip or it would be overloaded.
6. Do not power the COB strip while it's rolled, or it will be overheat and damaged.
7. Do not power the COB strip by another power source, like 120VAC or 120VDC, the electronic components will be damaged.
8. Keep the components from children.