



Product Description

Infinity Green (IG) Lighting Corporation LED Strip was designed and created to make innovation an objective with unique designs. Our strip allows low power usage with LED features extending up to 10 Meter & 15 Meters with adjustable cutting sizes up to your preference and serves at the top quality in the market. One driver and voltage regulator is enough to run the strip efficiently. In order to reduce time installation on the LED Strip, the installation was simply allowed most surfaces with 3M double-sided tape.



Specification Information	
Length:	10-15M (32.8-49.2 FT)
Rated Power	24v/96W-144W
Chips:	SMD 3825
Cutting Unit:	1.97 Inches
Environment:	Indoor (IP20)
CRI	90
Lumen Per Watt	92
Certification:	UL Listed
Life Span Warranty:	3 Years

- ### Features
- Easy Installation For Many Ways
 - Adjustable cutting sizing on LED Strip at your preference
 - Safety Input of 24VDC
 - Certified By UL Listing
 - Using 10mm width 3oz PCB to reduce the voltage dropping and make the strips running longer
 - Various Dimmable Option
 - Low Profile/Great Flexibilities
 - Channel Option

Ordering Steps

Product Purchasing Guideline

	Model Number	-	Color Temperature	-	Meter
Ex:	SLR-24	-	3090	-	10M
	SLR-24		2790 - 2700k		10M
	SLR-24		3090 - 3000k		15M
			4090* - 4000k		
			5090 - 5000k		



Installation Steps

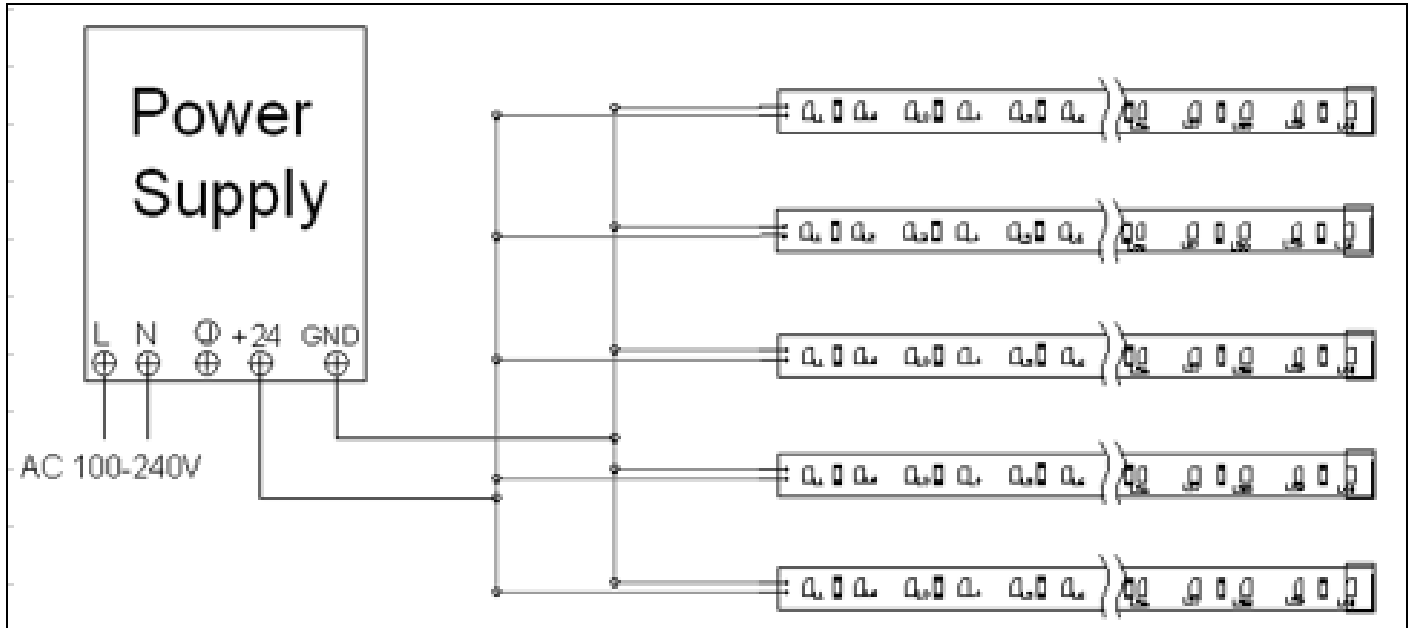

Guidelines

1. The max running length is 10 meters, better with a heat sink to help heat dissipation.
2. Usually, most of the power supply has an efficiency between 80%-95%, so when choosing the power supply, the total watts of the strips should be smaller than 80% of the rated power of the LED Strip Lights.
3. Adjusted the running length by only cutting where the small scissors are located on the strip.
4. Peel the 3M tape off and tape on the area and run the core.
5. Connect the Strip with the power supply

Wiring







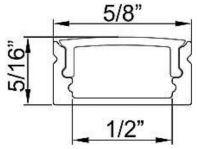

LED-Flexible SMD Linear Strip

One of the most common ways to install LED strip light is with an LED channel. In addition to protecting and concealing your LED strip, it provides a polished and professional look for your lighting installation. We offer channels that can be surface mounted, hung, clip mounted, recessed, magnetically adhered and stair mounted. Channel systems consist of two main parts: aluminum channel and a diffuser or lens. We offer a number of standard designs, as well as some specialized extrusions for specific applications. (More Detail: www.infingreen.com/channel-led/)

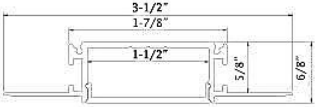
Aluminum Channel (Accessories)

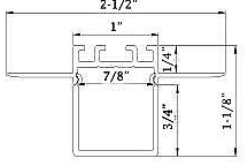
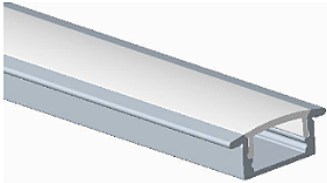
	<p>ALP6002 - Slim Aluminum LED Profile For Surface Mounted</p> 		<p>ALP6081R Aluminum profile with PC opal cover</p> 
	<p>ALP6013 Aluminum LED Profile For Recessed</p> 		<p>ALP6071 Aluminum LED Profile Trimless Recessed</p> 
	<p>ALP6014 Aluminum LED Profile For Surface Mounted</p> 		<p>ALP6110R Trimless Recessed LED Aluminum Profile Channel</p> 
	<p>ALP6083R Aluminum Profile with PC opal cover</p> 		<p>ALP6110S Aluminum LED Profile with linch Square Lens</p> 
	<p>ALP6006 Aluminum Profile For Corner Mounted</p> 		<p>ALP6001R Aluminum LED Profile for Recess Mounted</p> 



Safety Instructions

1. Open the package and check if all the components are complete, then unrolling the led strip, and connect the COBstrip to the controller and driver, and light it up to check if all parts are in good condition or not. The connect method should refer to the wiring diagram.
2. Clean the surface on the installation surface, make sure it's clean, dry, and smooth, Or it will reduce the adhesiveness of the back tape. Remember the back tape could be only used one time. The COB strip will fall off if the surface is not in good condition or the back tape is reused.
3. Measure the length required on the surface and cut the COB strip accordingly.
4. Tear off the back tape and paste the strip to the surface smoothly and correctly. Connect the COB strip to the controller and driver based on the diagram.
5. Fix the driver, make sure all the components are tightly and not fall off.

Warning

1. Do not use it outdoors or underwater.
2. Disconnect the power before installation.
3. The operating temperature is -10°C to $+40^{\circ}\text{C}$, please make sure the installation surface should be less than 40°C .
4. Do not use the products close to flammable materials.
5. Do not power the COB strip while it's rolled, or it will overheat and damage.
6. Do not power the COB strip by another power source, like 120VAC or 120VDC, the electronic components will be damaged.
7. Keep the components from children.
8. When installing the Any Led Strip, please use the installation safety instruction. The Led strip can be bent but not distorted, as shown below

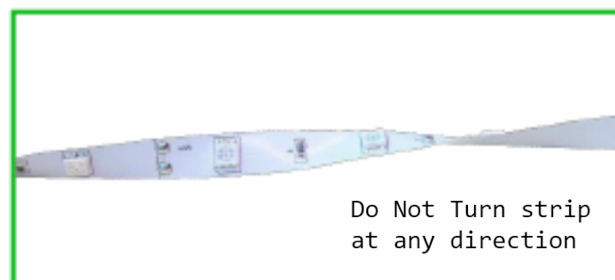
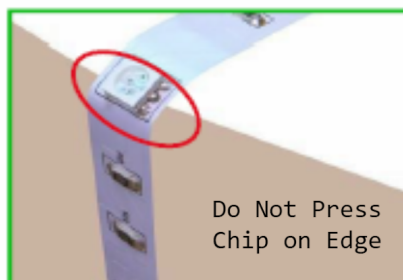
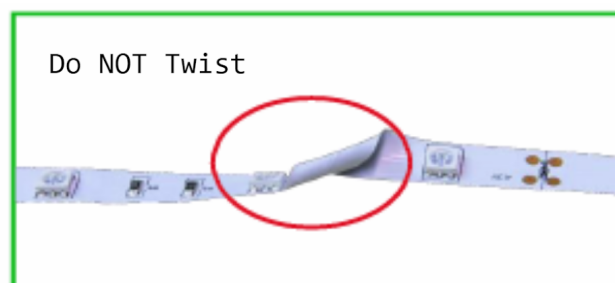



Infigreen: SLR-24-XXXX-(10M/15M)

LED-Flexible SMD Linear Strip
